

BMW

R1100GS

Schematics

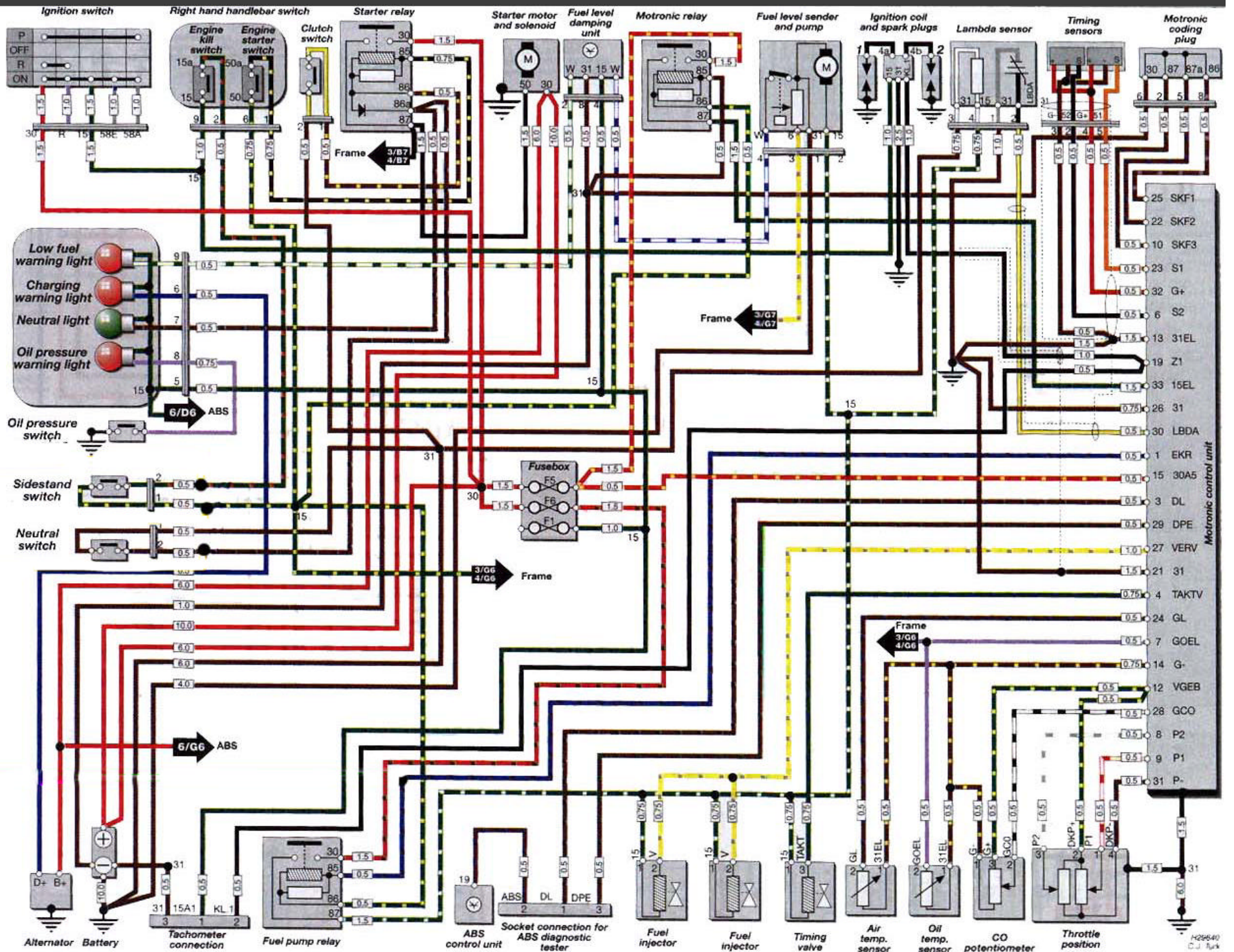

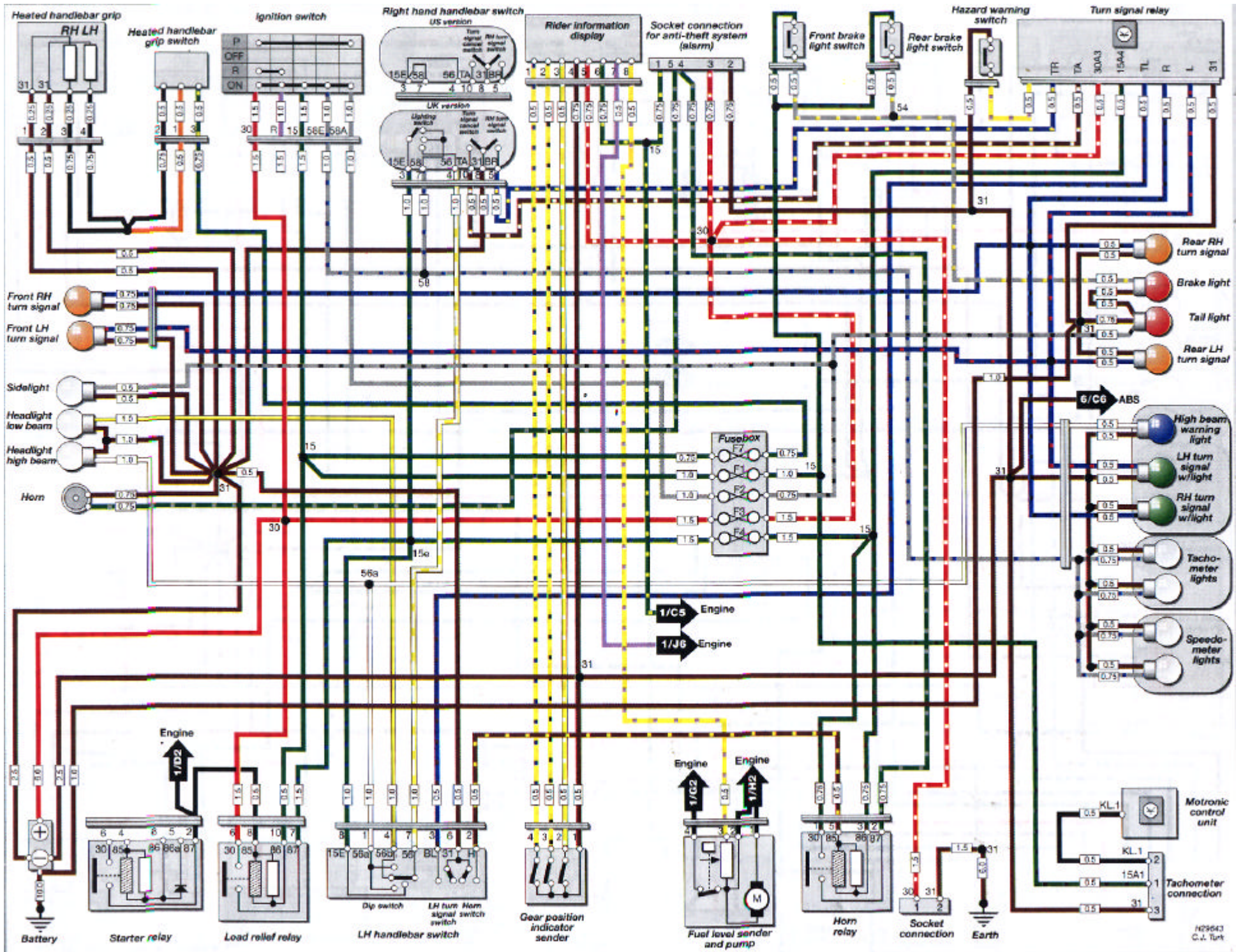

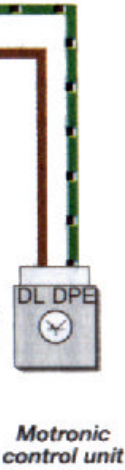
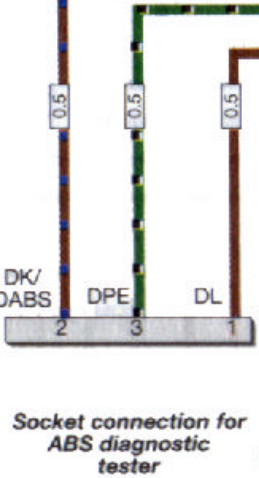
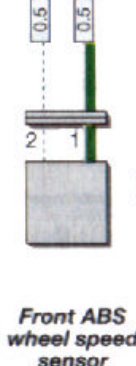
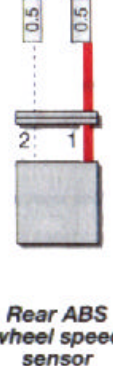
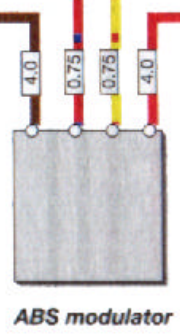
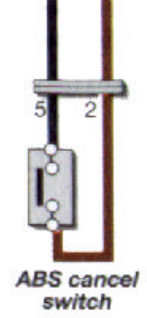
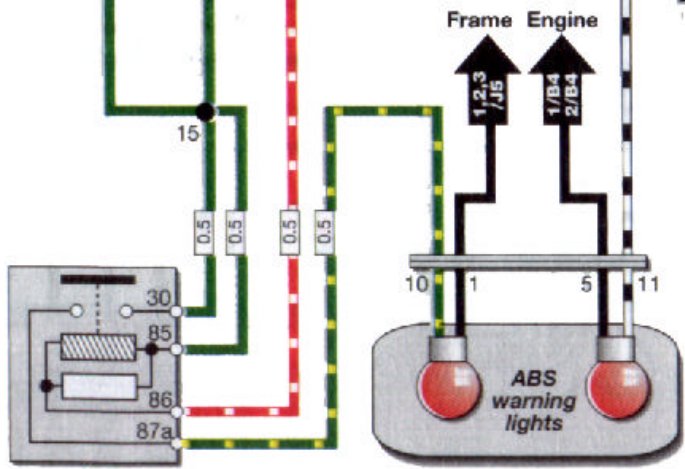
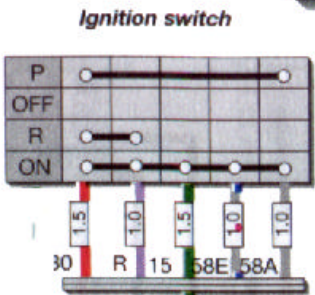
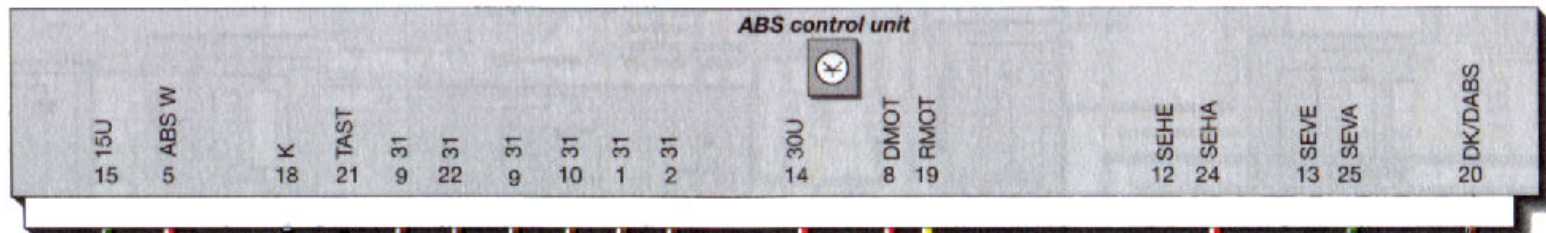

ABS warning relay

ABS cancel switch

Earth

ABS modulator

Alternator

Rear ABS wheel speed sensor

Front ABS wheel speed sensor

Socket connection for ABS diagnostic tester

Motronic control unit